



UltraLyte LR B

User's Manual

UltraLyte® LR B
User's Manual
Part Number 0144698

Copyright Notice:

Information in this document is subject to change without notice and does not represent a commitment on the part of Laser Technology, Inc. No part of this manual may be reproduced in any form or by any means, electronic or mechanical, including photocopying, recording, or information storage and retrieval systems, for any purpose other than the purchaser's personal use, without the express written consent of Laser Technology, Inc.

Copyright © Laser Technology, Inc., 2002. All rights reserved

Printed in the United States of America

First Edition: April 2002

Second Edition: June 2002

Trademarks:

UltraLyte, Marksman, 20/20, Criterion, and MapStar are registered trademarks of Laser Technology, Inc.

Patents:

This product is covered by pending patent applications and/or one or more of the following issued patents:

5,359,404
5,521,696
5,617,199
5,715,045

How to Contact LTI: Street Address: 7070 South Tucson Way
Englewood, CO 80112 USA
Phone: 1-303-649-1000
1-800-790-7364 (USA and Canada)
Fax: 1-303-649-9710
Web Site: www.lasertech.com
Email: service@lasertech.com

Table of Contents

Safety Precautions	3
Section #1 – Getting Started	5
About this Manual	5
Unpacking Your UltraLyte LR B.....	6
UltraLyte LR B Package.....	6
Available Accessories	6
About the UltraLyte LR B	6
Sensors.....	7
LCD Screen	7
Serial Port Connector	7
Sighting Scope	8
Button Panels	9
Fold-Away Shoulder Stock.....	10
Unfolding the Stock for Left-Handed Use.....	10
Unfolding the Stock for Right-Handed Use.....	10
Refolding the Stock.....	11
Attaching the Yoke	12
Inserting the Batteries	13
Powering ON the UltraLyte LR B	14
Powering OFF the UltraLyte LR B.....	14
Extending the Display Segment Test.....	14
Understanding the Display Indicators.....	15
Miscellaneous Display Features.....	17
Adjusting the Aiming Dot's Intensity	18
Viewing the Firmware Revision Number	19
Restoring the Factory Defaults.....	20
Listening to the UltraLyte LR B	21
Understanding Error Conditions	21
Error Codes	22
RFI Considerations.....	22
Section #2 – Speed Measurements	23
Taking a Sample Measurement	23
Choosing a Roadside Location.....	24
Line of Sight.....	24
The Cosine Effect	25
Measuring a Moving Vehicle.....	27
Jam Indicator	28
Using the Weather Filter	29
Section #3 – Survey Measurements	31

Section #4 – Instrument Tests	33
Display Integrity Test	33
Scope Alignment	34
Scope Alignment Test	34
Scope Alignment Procedure.....	35
Reference Frequency Test	37
Instrument Confidence Checks	37
Fixed Distance Test.....	38
Delta Distance Test.....	40
Section #5 – Maintenance	43
Operating Temperature	43
Moisture and Dust Protection	43
Shock Protection	43
Cleaning and Storage	43
Caring for the Scope.....	44
Checking the Screen Display	44
Resetting the Factory Default Settings	44
Section #6 – Serial Data Interface	45
Data Formats	45
Format Parameters	45
20-20 Download Format	46
Version ID Requests	46
Example Version ID Messages	46
Speed/Range Data Message Format.....	47
Example Speed/Range Messages	47
Criterion 400 Download Format.....	48
Version ID Requests	48
Example Version ID Messages	48
Survey Data Message Format	49
Example Survey Messages.....	49
Section #7 – Specifications	51
Section #8 – Troubleshooting Tips	53
Index	55

Safety Precautions

Avoid staring directly at the laser beam for prolonged periods.



The UltraLyte LR B is designed to meet FDA eye safety requirements and is classified as eye-safe to Class 1 limits, which means that virtually no hazard is associated with directly viewing the laser output under normal conditions. As with any laser device, however, reasonable precautions should be taken in its operation. It is recommended that you avoid staring into the transmit aperture while firing the laser. The use of optical instruments with this product may increase eye hazard.

Never attempt to view the sun through the scope.

Looking at sun through the scope may permanently damage your eyes.

Never point the instrument directly at the sun.

Exposing the lens system to direct sunlight, even for a brief period, may permanently damage the laser transmitter.

Do not expose the instrument to extreme temperatures.

UltraLyte LR B components are rated for a temperature range of -22° F to +140° F (-30° C to +60° C). Do not expose the instrument to temperatures outside that range.

Section #1 – Getting Started

Laser Technology's UltraLyte LR B is part of the UltraLyte family of handheld laser speed and ranging devices. Compared to the other UltraLyte models, the UltraLyte LR B:

- Has simplified menus and options.
- Includes a built-in Weather Filter that is an alternate speed measurement mode. The Weather Filter is a simplified UltraLyte gating option. This factory-defined gate ensures that targets are beyond the range where rain and snow can affect the laser's ability to capture a speed reading.
- Displays one speed reading after another until you release the **TRIGGER**.

Other Features of the UltraLyte LR B include:

- Liquid Crystal Display (LCD) screen for instant access to measurements and options.
- Serial output port for easy connection to a data collector or remote computer.
- Fully adjustable, fold-away shoulder stock.
- Sighting scope with in-scope red aiming dot and in-scope measurement display.
- Two 3-button panels that provide quick and easy access to the instrument functions.
- Sounds and visual indicators that ensure confidence of positive target acquisition.

About this Manual

This manual describes the UltraLyte LR B and is divided into the following sections:

	Page		Page
<input type="checkbox"/> Safety Precautions	3	<input type="checkbox"/> Maintenance	43
<input type="checkbox"/> Getting Started	5	<input type="checkbox"/> Serial Data Interface	45
<input type="checkbox"/> Speed Measurements	23	<input type="checkbox"/> Specifications	51
<input type="checkbox"/> Survey Measurements	31	<input type="checkbox"/> Troubleshooting Tips	53
<input type="checkbox"/> Instrument Tests	33	<input type="checkbox"/> Index	55



Sample screen displays appear throughout this manual. The samples may not exactly match your particular UltraLyte LR B. When looking at these sample screen displays, you may need to substitute "**KMH**" for "**MPH**" and "**meters**" for "**feet**".

Unpacking Your UltraLyte LR B

When you receive your UltraLyte LR B, check to make sure that you have received everything that you ordered, and that it all arrived undamaged.

UltraLyte LR B Package

- UltraLyte LR B instrument
- Two C batteries
- User's manual
- Carrying case

Available Accessories

You may have also ordered one or more of these optional accessories:

- UltraLyte 2X Converter Upgrade
- UltraLyte Battery Eliminator
- Serial data cable (remote trigger optional)
- Yoke (includes adapter for monopod/tripod mounting)
- Monopod
- Tripod

About the UltraLyte LR B

Figure 1 shows the UltraLyte LR B's front and rear panels.

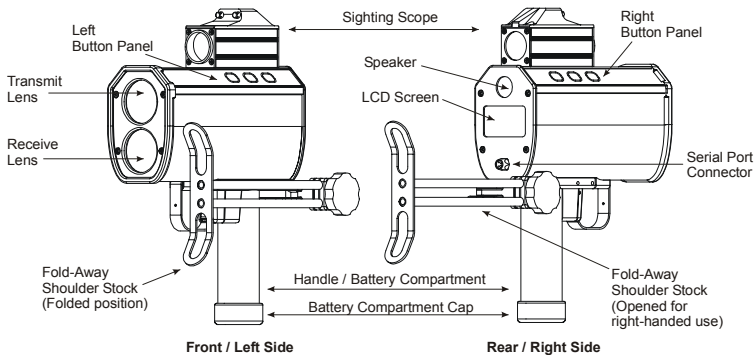

Figure 1. Two Views of the UltraLyte LR B

Sensors

The UltraLyte LR B has two lenses on the front panel. The top lens transmits the infrared laser signals. The bottom lens receives signals back from the target and feeds signal information to the internal circuitry.

The internal circuitry consists of a laser range sensor and timing, analysis, computation, and display circuits. The UltraLyte LR B determines distance through its laser range sensor, by measuring the time of flight of short pulses of infrared light. The UltraLyte LR B has a broad spectrum of sensitivity, and can work with both reflective and non-reflective targets.

The maximum measurement distance varies with target and environmental conditions. The absolute maximum is about 3280 feet (1000 meters).

LCD Screen

The LCD Screen displays menu items, option indicators, error codes, and speed and survey measurement results.

Serial Port Connector

The serial port connector allows you to connect the instrument to a data collector or remote computer. For more information about the Serial Data Interface, [see page 45](#).

Sighting Scope

Mounted on top of the UltraLyte LR B is a single-power sighting scope. The scope features:

- Adjustable polarizing light filter to optimize viewing contrast. Figure 2 shows the polarizing light filter's adjustment ring.

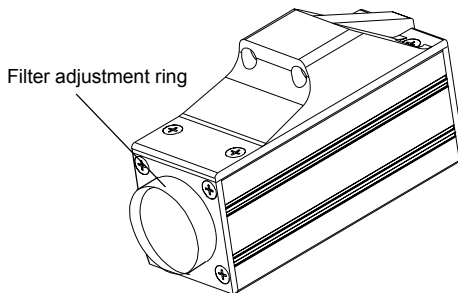

Figure 2. Polarizing Light Filter

- In-scope red aiming dot to help you aim accurately to the target.
- In-scope measurement display. As Figure 3 shows, the appearance of the aiming dot varies, depending if the Speed Mode or Survey Mode is active. In these examples, the number '87' represents the measured value, either a speed or a distance, depending on the active mode.

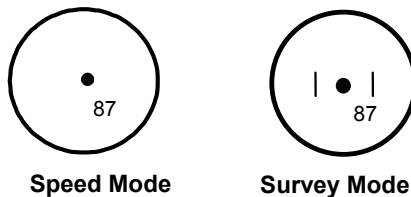

Figure 3. In-scope Aiming Dot



You can vary the intensity of the red dot to account for different lighting conditions. For more information, [see page 18](#).

Button Panels

The UltraLyte LR B has two, 3-button panels; one on each side of the instrument. The buttons provide easy access to the instrument functions. Table 1 lists the buttons and the functions of each.

Table 1. Button Names and Functions

	Button	Function
Right Panel	SPEED MODE	Activates the instrument's speed measurement mode.
	WEATHER FILTER	Activates the instrument's alternate speed measurement mode.
	SURVEY MODE	Activates the instrument's survey measurement mode.
Left Panel	TEST OPTIONS	Activates the instrument's test mode.
	BRIGHTNESS CONTROL	Varies the intensity of the in-scope red aiming dot.
	BACKLIGHT POWER OFF	<i>Press and release:</i> toggles the display backlight ON/OFF.
		<i>Press and hold for 2.5 seconds:</i> Powers OFF the instrument.



This manual simplifies button names to relate to current function instead of matching the instrument's label.

For example:

Button Names According to the Label

Press the **BACKLIGHT POWER OFF** button.

Button Names in this Manual

Press the **BACKLIGHT** button.

-or-

Press the **POWER OFF** button.

Fold-Away Shoulder Stock

The shoulder stock is fully adjustable, and is designed for either left-handed or right-handed use.

Unfolding the Stock for Left-Handed Use

Refer to the instructions and Figure 4 below to unfold the stock for left-handed use.

1. Turn the tension knob counter-clockwise to loosen the stock.
2. Rotate the stock 180 degrees.
3. Turn the tension knob clockwise to retighten the stock.

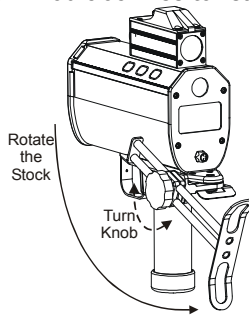

Figure 4. Unfolding the Shoulder Stock for Left-Handed Use

Unfolding the Stock for Right-Handed Use

Refer to the instructions and Figure 5 below to unfold the stock for right-handed use.

1. Hold the instrument firmly, and press down on the retaining plate with enough force to disengage the plate from the stock's retainer peg.
2. Pull the stock away from the body of the instrument and release the plate.
3. Rotate the stock to the right until the retainer peg re-engages. You should hear a loud click when the peg re-engages.

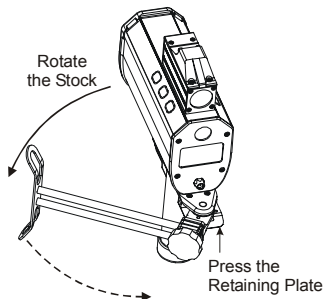

Figure 5. Unfolding the Shoulder Stock for Right-Handed Use

Adjusting the Length and Angle

Refer to the instructions and Figure 6 below to adjust the stock's length and angle.

Length:

1. Loosen the tension knob.
2. Slide the stock back and forth to desired position.
3. Retighten the tension knob.

Angle:

1. Loosen the tension knob slightly.
2. Move the stock up or down. Usually, it is best if the stock is at a slight downward angle.

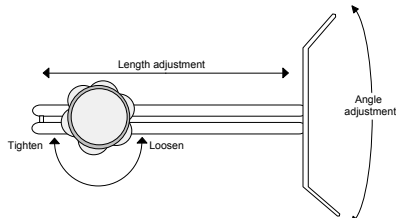

Figure 6. Adjusting the Shoulder Stock

Refolding the Stock

Refer to the instructions below to refold the stock.

1. Extend the stock to its full length.
2. Reverse the procedure that you used to open it (see page 10).



Although the stock can be folded on either side, the UltraLyte LR B only fits in its carry case when the stock is fully extended and folded on the *left side* of the instrument.

Attaching the Yoke

The UltraLyte Yoke is an available accessory that allows you to mount the UltraLyte LR B on a monopod or tripod. Refer to the instructions and Figure 7 below to attach the yoke to the UltraLyte LR B.



The yoke can be mounted on either side of the instrument. When the yoke is mounted on the *left side*, the entire assembly fits into the padded carrying case.

1. Screw the mounting bracket and yoke adapter into the mounting holes on the side of the instrument base.
2. Fit the yoke onto the mounting bracket.
3. Tighten the knob.

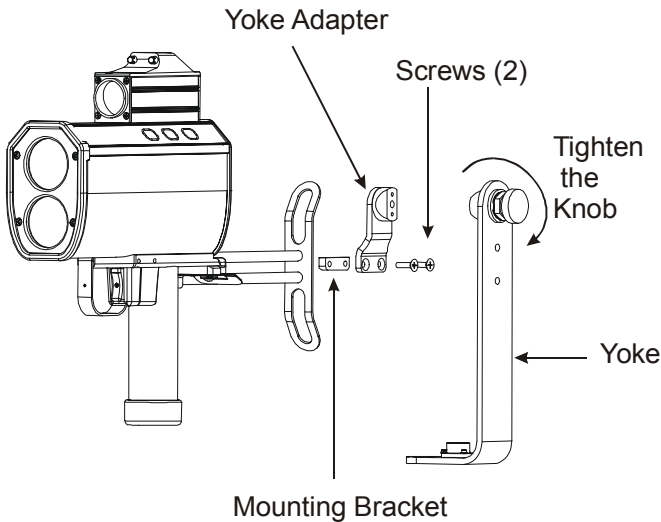

Figure 7. Attaching the Yoke Adapter and Yoke

Inserting the Batteries

Two C batteries are required to power the UltraLyte LR B. Refer to the instructions and Figure 8 below when inserting the batteries.

1. Remove the battery compartment cap by twisting counter-clockwise.
2. Insert the two batteries, positive end first, into the battery compartment in the instrument handle.
3. Replace the cap.
4. Twist the cap clockwise until it stops and is secure. Be careful to not over-tighten the cap.

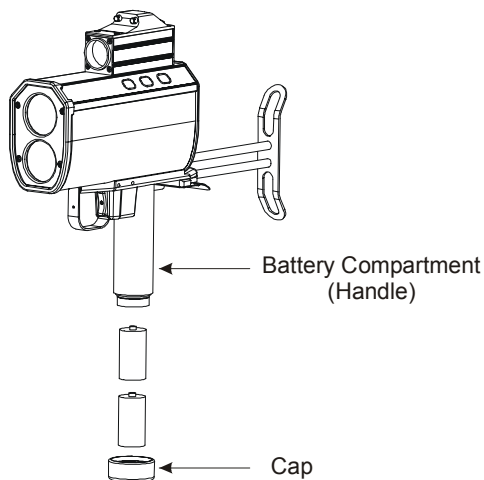

Figure 8. Inserting the Batteries

Battery Voltage Level

The UltraLyte LR B continuously monitors its power source. LTI has defined an acceptable battery voltage range to ensure that the instrument has sufficient battery voltage to guarantee correct operation.

- *The "BATT" display feature flashes on the screen* if the battery voltage drops to the upper end of the acceptable battery voltage range. It continues to flash as long as battery voltage is within the acceptable range. You should replace the batteries as soon as possible. The display backlight is not accessible during low battery situations.
- *The "BATT" indicator stops flashing, and stays displayed on the screen* if the battery voltage level drops below the acceptable battery voltage range. If you fail to replace the batteries, the button panels will lock out.

Powering ON the UltraLyte LR B

To power ON the UltraLyte LR B:

1. Press the **TRIGGER**. Briefly, the screen display should look like Figure 9 below, and then the display will change to the Speed Measurement Screen. See Figure 15 on page 23.

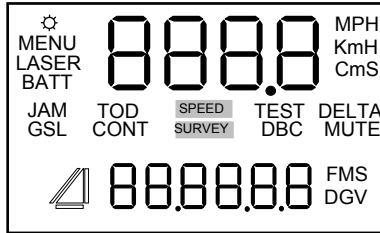

Figure 9. LCD Display Segments

Powering OFF the UltraLyte LR B

To power OFF the UltraLyte LR B:

1. Press and hold the **POWER OFF button** for approximately 2.5 seconds.



To help save its batteries, the UltraLyte LR B has a factory-defined power OFF interval. The instrument will automatically power OFF if there is no activity for a period of 15 minutes. Instrument activity includes any button presses or serial communication.

Extending the Display Segment Test

Extending the Display Segment Test lets you confirm that all display indicators are working. Refer to the instructions below to extend the display segment test.

1. Verify that the UltraLyte LR B is powered OFF.
2. Press and hold the **TRIGGER**.
3. Refer to Figure 9 (above) to ensure that all of the display segments are showing on your UltraLyte LR B.
4. Release the **TRIGGER**. Upon release of the **TRIGGER**, the display will change to the Speed Measurement Screen. See Figure 15 on page 23.









If you need assistance, contact Laser Technology, Inc. See the inside front cover for LTI contact information.

Understanding the Display Indicators

Table 2 lists the display indicators and the function of each. These are presented in order of location on the display, from left to right starting in the upper left corner. [See Figure 9 on page 14.](#)

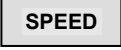
Table 2. Display Indicators

Display Indicator	Function	Explanation
	Display Backlight	<i>Visible</i> – The LED backlight is ON.
		<i>Not Visible</i> – The LED backlight is OFF.
MENU	Options Menu	This feature is not available on the UltraLyte LR B.
LASER	Laser Fire	The instrument's laser is firing.
BATT	Battery	<i>Flashing</i> – Battery voltage is low.
		<i>Steady</i> – Battery voltage is too low. Power OFF the instrument.
		<i>Not Visible</i> – Battery voltage is within the factory-defined acceptable range.
	Upper Display	Provides access to speed measurements and messages.
MPH KmH CmS	Speed Units	MPH = Miles per Hour KmH = Kilometers per Hour CmS = Centimeters per Second
JAM	Jam Detection	Indicates Jamming Signal.
GSL	Gate Short Long	When the instrument's Weather Filter is active, the "GS" indicator is displayed. This is an alternate speed measurement mode that includes a factory-defined gate setting.

Display Indicator	Function	Explanation
TOD	Time Over Distance	This feature is not available on the UltraLyte LR B.
CONT	Continuous Mode	This feature is not available on the UltraLyte LR B.
	Speed Mode	The instrument's Speed Mode is active
	Survey Mode	The instrument's Survey Mode is active
TEST	Test Mode	The instrument's Test Mode is active.
DBC	Distance Between Cars	This feature is not available on the UltraLyte LR B.
DELTA	Distance Difference	This feature is not available on the UltraLyte LR B.
MUTE	Mute (silent) Mode	This feature is not available on the UltraLyte LR B.
	Survey Icon	Indicates the type of survey measurement being taken (<i>slope distance only</i>).
	Lower Display	Provides access to range measurements and messages.
F M	Distance Units	F = Feet M = Meters
S	Time Unit	This feature is not available on the UltraLyte LR B.
D G	Inclination Units	This feature is not available on the UltraLyte LR B.
V	Power Units	Displays when the TRIGGER is pressed during the Reference Frequency Test.

Miscellaneous Display Features

Table 3 lists the miscellaneous display features that are not part of the Display Segment Test.

Table 3. Miscellaneous Display Features

Display Feature	Explanation	Refer to Pages
br xx	The in-scope red aiming dot's intensity setting.	18
CLEAR	<i>When restoring factory defaults,</i> indicates that the task was completed.	20
	<i>When the Speed Mode is active,</i> indicates that the Weather Filter is OFF.	23
dEF	The instrument is restoring the factory defaults.	20
Exx	Error Code. An error condition has occurred during a measurement or in the system hardware.	21-22
F OUT	The instrument's Reference Frequency Test is active.	37-38
FiLteR	Appears at the bottom of the screen when the instrument's Weather Filter is toggled ON.	29
rEF	The instrument's Reference Frequency Test is active.	37-38
tt	The instrument's test tone is active. Used during the Scope Alignment Test and Procedure.	34-37

Adjusting the Aiming Dot's Intensity

The in-scope red aiming dot has eight intensity settings from *OFF* (00) to *BRIGHT* (07). Refer to the instructions and Figure 10 below to adjust the red aiming dot's intensity.

1. Press the **BRIGHTNESS CONTROL button**. The display should look similar to Figure 10. The current setting is whatever "**br xx**" is displayed. The factory default setting is "br 05" as shown in the figure.

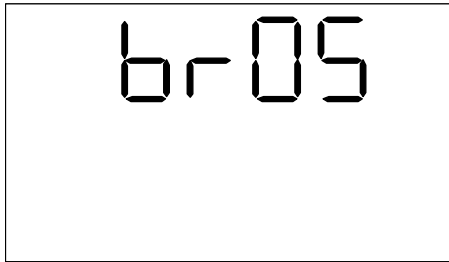

Figure 10. Aiming Dot Intensity Setting

2. Press the **BRIGHTNESS CONTROL button** until the setting is correct. It's easy to get the correct setting if you look through the scope while making the adjustment.
3. Press the **TRIGGER** to return to the measurement mode that was most recently active. Otherwise, press the button that corresponds with whatever it is that you want to do next. For more information, [see Table 2 on Page 14](#).



- Each time you press the **SCOPE BRIGHTNESS button**, the "br xx" value increases by 1.
- If you press the **SCOPE BRIGHTNESS button** while "br 07" is displayed, you will see "br 00" next.
- Powering OFF the instrument does not change this setting. The next time the instrument is powered ON, the setting will be the same.

Viewing the Firmware Revision Number

Firmware is the internal software that controls how the UltraLyte LR B works. The firmware revision number provides manufacturing information about your UltraLyte LR B. It can only be viewed at power ON. Refer to the instructions below to view the firmware revision number.

1. Verify that the UltraLyte LR B is powered OFF.
2. Press and hold the **TRIGGER**.
3. Press the **SURVEY MODE button**. The display should look similar to Figure 11.
4. Release the **SURVEY MODE button**.

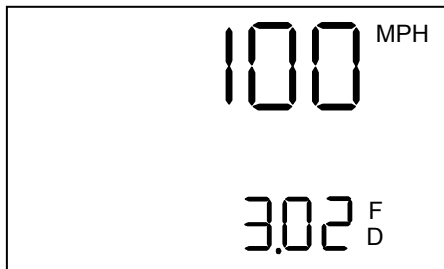

Figure 11. Model and Firmware Revision Number

In this example:

- *100* is the model number.
 - *3.02* is the software revision number.
 - *MPH* (miles per hour) is the factory default speed unit.
 - *F* (feet) is the factory default range unit.
 - *D* (degrees) is the factory default angular unit.
5. Release the **TRIGGER**. The display will change to the Speed Measurement Screen, [see Figure 15 on page 23](#).

For future reference, note the firmware revision number here: _____.

Restoring the Factory Defaults

The UltraLyte LR B has one user-selectable option — the in-scope aiming dot's intensity. Although, you may never need to, you can restore the instrument's factory default settings. Refer to the instructions and Figures 12 and 13 below to restore the factory default for the in-scope aiming dot's intensity.

1. Verify that the UltraLyte LR B is powered OFF.
2. Press and hold the **TRIGGER**.
3. Press and hold the **BACKLIGHT button**.
The display should look like Figure 12.



Figure 12. Restoring the Factory Defaults

4. Continue to hold the **TRIGGER** and the **BACKLIGHT button** until the **CLEAR** indicator is displayed as Figure 13 shows.



Figure 13. Factory Defaults Restored

5. Release the **TRIGGER** and the **BACKLIGHT button**.
The display will change to the Speed Measurement Screen, see [Figure 15 on page 23](#).

Listening to the UltraLyte LR B

The UltraLyte LR B emits a variety of beeps and tones during use. The sounds vary and depend on what the instrument is doing. With experience, you will be able to tell what is happening simply by listening. Table 4 lists and explains each of the sounds.

Table 4. Sounds and What They Mean

Sound	Explanation
High-Pitched Beep	The instrument successfully completed the intended speed measurement.
Double High-Pitched Beep	At power ON. The instrument successfully completed the intended survey measurement.
Single Low-Pitched Beep	The instrument was not able to take the intended measurement due to an error. An error code is displayed to indicate the nature of the error.
Low-Pitched Growl	The instrument is attempting to lock onto a target.
High-Pitched Oscillating Ring	Jam tone. The instrument's laser return sensor is being overwhelmed by light.

Understanding Error Conditions

Error conditions can occur in a measurement or in the system hardware. To make sure that you never get an erroneous speed reading, the UltraLyte LR B monitors both the system hardware and the measurement. When the instrument detects an error condition, it displays an error code instead of a measurement.

Error codes are in the form "E xx ", where " xx " is an error code number. Figure 14 shows an E03 error code, *Measurement error – unstable targeting*.

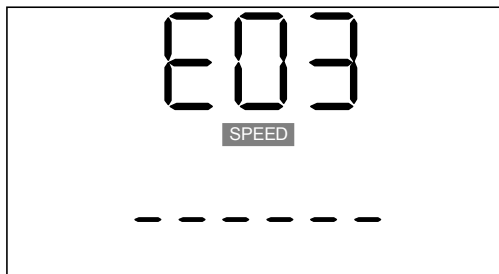

Figure 14. Sample Error Code Display

Error Codes

Table 5 lists and explains each of the possible error codes.

Table 5. Error Codes and What They Mean

Code	Explanation
doF	Display overflow. The measurement exceeds the display capacity. It is possible to receive a doF message in the scope and still have a valid measurement display on the screen.
E01	Measurement error - target never acquired. The target was out of range or was too close.
E02	Measurement error - insufficient data. The instrument's view was obstructed or the target moved out of range.
E03	Measurement error - unstable targeting. Caused by poor aiming or by panning off the target.
	Measurement error - low level of interference from a light source such as a headlight or a laser jamming device.
E07	Jam detect - high level of interference from a light source such as a headlight or laser jamming device.
E52	Temperature too cold. Stop operation.
E53	Temperature too hot. Stop operation.
E54	Calibration or memory checksum failure.
E55	If the error persists, contact Laser Technology, Inc.
E56	See the inside front cover for LTI contact information.
E60	
E61	
E62	
E63	

RFI Considerations

The UltraLyte LR B does not display a specific error message indicating the presence of radio frequency interference (RFI). The instrument's electronics have been designed for optimum RFI immunity.



If RFI is present, the instrument displays an error code. The exact code depends on the level and nature of the RFI.

Section #2 – Speed Measurements

When you power ON the UltraLyte LR B, the screen display should look similar to Figure 15.

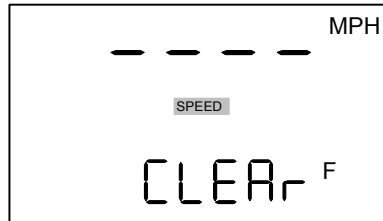

Figure 15. Initial Speed Measurement Screen

- The "SPEED" indicator means that the instrument is in Speed Mode and is prepared to take a speed & range measurement.
- Dashes indicate where the speed measurement will appear.
- "MPH" means the speed will be measured in miles per hour. ("KmH" means kilometers per hour).
- The word "CLEAR" appears at the bottom of the screen, and will be overwritten by the distance to the target vehicle when a speed measurement is completed.
- "F" means the distance will be measured in feet. ("M" indicates meters.)

Taking a Sample Measurement

Refer to the instructions below to take a sample speed measurement.

1. Ensure that the UltraLyte LR B is powered ON and that the Speed Mode is active.
2. Use the sighting scope to aim the instrument to a convenient target — an interior wall will do.
3. To fire the laser:
 - Press and hold the **TRIGGER**. The laser will fire after a short delay (about one-half of a second).
 - or-
 - Press the **TRIGGER** twice. The 1st press turns on the in-scope red aiming dot. The 2nd press takes the measurement.
4. Continue to press the **TRIGGER** and keep the instrument sighted on the target:
 - A *low-pitched growl* means that the instrument is attempting to lock onto the target.
 - A *low-pitched beep* means that a measurement error occurred. An error code will be displayed.

- A *high-pitched beep* means that a speed was captured. As long as you hold the **TRIGGER**, the instrument will continue to take speed measurements. The measured speed will be displayed on the LCD screen and will be projected on the scope, just below the aiming dot.

After you release the **TRIGGER** the instrument will display the most recent speed reading and the distance at which it was captured or an error code. When the most recent speed reading is displayed, the display screen will look similar to Figure 16.

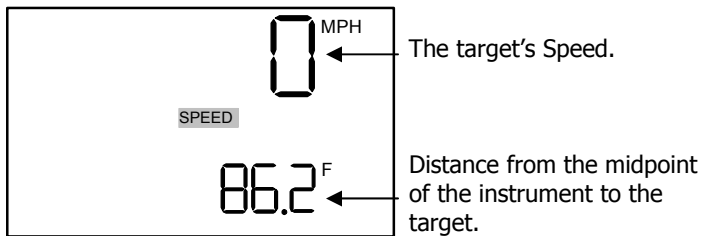

Figure 16. Sample Speed Measurement - Wall

Choosing a Roadside Location

When choosing a spot on the side of the road for measuring moving vehicles, you will need to consider:

- Do you have a clear line of sight?
- What is the angle between the instrument's position and the target vehicle's direction of travel? (*approximately*)
- What is the distance to the target vehicles? (*approximately*)
- How is the weather? Will you need to use the Weather Filter?

Line of Sight

Ideally, you should have a clear line of sight to the target vehicle. However, if there is a break in the beam, the instrument may be able to accumulate enough data to capture the target vehicle's speed.

- *If there is a momentary break in the beam*, the instrument will accumulate data and may be able to capture the target vehicle's speed. The instrument will display an error code if it cannot capture the target vehicle's speed.
- *If there is an extended break in the beam*, the instrument will display an error code.

The Cosine Effect

If the target vehicle is moving directly toward or away from you, the speed measured by the UltraLyte LR B is identical to the vehicle's true speed. However, the instrument is usually set up on the side of the road for safety. This results in an angle between the instrument's position and the target vehicle's direction of travel. When the angle is significant, the measured speed is less than the target's true speed. The phenomenon is known as the *cosine effect*. Cosine is the trigonometric function that relates to this phenomenon.

The difference between the measured speed and the true speed depends upon the angle between the instrument's ideal position—the position where targets would be moving in direct line with the instrument—and its actual position.



- *The larger the angle, the lower the measured speed.*
- The effect always works to the motorist's advantage.
- Loosely speaking, the cosine effect is not significant as long as the angle remains small. Table 6 shows this effect.

Table 6. Measured Speed by Angle: The Cosine Effect

Angle (degrees)	True Speed				
	30 mph	40 mph	50 mph	60 mph	70 mph
	Measured Speed (mph)				
0	30.00	40.00	50.00	60.00	70.00
1	29.99	39.99	49.99	59.99	69.99
3	29.96	39.94	49.93	59.92	69.90
5	29.89	39.85	49.81	59.77	69.73
10	29.54	39.39	49.24	59.09	68.94
15	28.98	38.64	48.30	57.94	67.61
20	28.19	37.59	46.99	56.38	65.78
45	21.21	28.28	35.36	42.43	49.50
90	00.00	00.00	00.00	00.00	00.00

(degrees)	50 kmh	70 kmh	90 kmh	110 kmh	130 kmh
		Measured Speed (KmH)			
0	50.00	70.00	90.00	110.00	130.00
1	49.99	69.99	89.99	109.98	129.98
3	49.93	69.90	89.88	109.85	129.82
5	49.81	69.73	89.66	109.58	129.50
10	49.24	68.94	88.63	108.33	128.02
15	49.30	67.62	86.93	106.25	125.57
20	46.98	65.78	84.57	103.37	122.16
45	35.36	49.50	63.64	77.78	91.92
90	00.00	00.00	00.00	00.00	00.00

The cosine effect decreases as the range to the target vehicle increases.

- *At the maximum range of the instrument*, the vehicle is so far away that the angle between it and the instrument is very small indeed. The instrument's perception of the target's speed is identical to its true speed.
- *As the vehicle approaches*, the angle increases until it becomes large enough to affect the measurement.



To minimize the cosine effect, keep the angle small. Set up the instrument as close to the road as possible without creating safety risks, and target down the road at ranges sufficient to keep the angular difference small.

Table 7 shows acceptable parameters for minimizing the cosine effect. The chart indicates the percentage of true speed measured, given the distance from the roadway and the distance from the target vehicle. To find a target's measured speed, multiply the true speed by the number in the chart.

Table 7. Percentage of True Speed Measured

Distance off the Roadway (feet)	Range to Target Vehicle				
	100 ft	250 ft	500 ft	1000 ft	2000 ft
	<i>fraction of true speed that will be measured</i>				
10	.9950	.9992	.9998	.9999	1.0000
25	.9682	.9950	.9987	.9997	.9999
50	.8660	.9798	.9950	.9987	.9997
100	.0000	.9165	.9798	.9950	.9987
200	.0000	.6000	.9165	.9798	.9950

(meters)	30 m	100 m	150 m	300 m	600 m
	<i>fraction of true speed that will be measured</i>				
	3	.9950	.9995	.9998	.9999
10	.9682	.9950	.9987	.9997	.9999
15	.8660	.9886	.9950	.9987	.9997
30	.0000	.9539	.9798	.9950	.9987
60	.0000	.7999	.9165	.9798	.9950

The diagonal created by the boldface numbers indicates the boundary between *acceptable* and *unacceptable* parameters.

- *Numbers above the diagonal* are acceptable margins of error.
- *Numbers below the diagonal* are unacceptable margins of error.

Remember that the cosine effect is always in the motorist's favor.



As a general rule, do not exceed 10 feet off the road for every 100 feet shooting down range to the targets. If target vehicles will be 500 feet down the road, set up no more than 50 feet off the road.

Measuring a Moving Vehicle

Refer to the instructions below to use the UltraLyte LR B to measure the speed of a moving vehicle.

1. Ensure that the UltraLyte LR B is powered ON and that the Speed Mode is active.
2. Use the sighting scope to aim the instrument at the target vehicle's license plate area and press the **TRIGGER**.
3. Continue to press the **TRIGGER** and keep the instrument sighted on the target
 - *A low-pitched growl* means that the instrument is attempting to lock onto the target.
 - *A low-pitched beep* means that a measurement error occurred. An error code will be displayed.
 - *A high-pitched beep* means that a speed was captured. As long as you hold the **TRIGGER**, the instrument will continue to take speed measurements. The measured speed will be displayed on the LCD screen and will be projected on the scope, just below the aiming dot.

While the instrument is attempting to lock onto the target, as long as the **TRIGGER** is kept pressed, it will retry the speed measurement.

- Depending upon its configuration, the instrument will try up to 10 times or more. Information is accumulated until it gets a good measurement or generates an error code.
- Consequently, it is very important that the aiming point on the target remain constant for the entire measurement time. If you move the instrument off the aiming point, it will generate an error code instead of capturing a speed reading.

After you release the **TRIGGER** the instrument will display the most recent speed reading and the distance at which it was captured or an error code. When the most recent speed reading is displayed, the display screen will look similar to Figure 17.

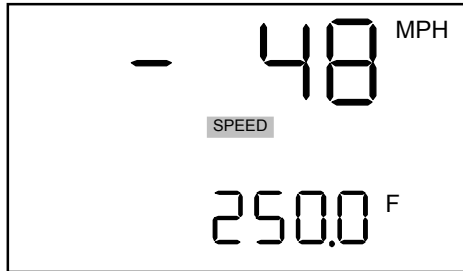

Figure 17. Sample Speed Measurement - Departing Vehicle

- The speed displays as a *negative number* if the target was going away from you when it was measured.
- The speed displays as a *positive number* if the target was approaching you when it was measured.

Jam Indicator

The JAM display indicator ([page 15](#)) on the back panel screen may blink during a measurement, and may be accompanied by the jam tone ([page 21](#)). This indicates that the instrument is being flooded by light and is having difficulty detecting its own signal. There are two possible situations:

- You are targeting a strong light source such as headlights.
- or-
- A targeted vehicle is employing a laser jamming device.

Regardless of the level of interference, you will never get an erroneous speed reading.

- *At a low level of interference*, a speed may be captured or an E03 error code may be displayed.
- *At a high level of interference*, an E07 error code will be displayed.

Using the Weather Filter

Moisture is reflective. Weather such as rain, snow, or fog can make it difficult for the laser to receive signals back from the target. This is especially true when you are trying to capture speeds at close range. The UltraLyte LR B includes a built-in Weather Filter that is an alternate speed measurement mode. When the Weather Filter is active, the factory-defined gate setting increases the instrument's minimum range from 50 ft to 250 ft (15 m to 76 m). Increasing the minimum range ensures that the laser only acquires targets beyond the range where weather affects the laser's ability to capture a speed reading.

When the Weather Filter is *active*:

- The "SPEED" indicator is displayed.
- The "GS" indicator appears on the screen, and word "FiLtEr" appears at the bottom of the display screen until it is overwritten by the distance to the target vehicle when a speed measurement is completed.
- Targets must be a distance greater than 250 feet (76 meters).
- The instrument's maximum range is *not* changed.
- Other than the above items, the UltraLyte LR B operates the same as when the Speed Mode is active and the Weather Filter is OFF ([see page 23](#)).

Refer to the instructions and Figure 18 below to activate the Weather Filter.

1. Ensure that the UltraLyte LR B is powered ON.
2. Press the **WEATHER FILTER** button.
The display should look similar to Figure 18.

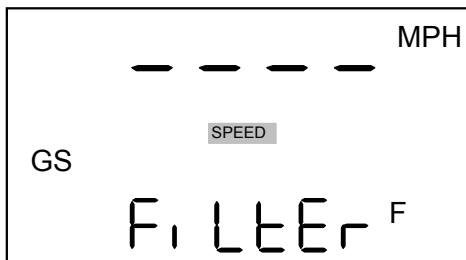

Figure 18. Initial Screen When the Weather Filter is Active

3. Aim the instrument at the target vehicle's license plate area and press the **TRIGGER**. A low-pitched growl begins, indicating the instrument is trying to acquire a lock on the target.

4. Continue to press the **TRIGGER** and keep the instrument sighted on the target:
 - A *low-pitched growl* means that the instrument is attempting to lock onto the target. A *low-pitched beep* means that a measurement error occurred. An error code will be displayed.
 - A *high-pitched beep* means that a speed was captured. As long as you hold the **TRIGGER**, the instrument will continue to take speed measurements. The measured speed will be displayed on the LCD screen and will be projected on the scope, just below the aiming dot.

While the instrument is attempting to lock onto the target, as long as the **TRIGGER** is kept pressed, it will retry the speed measurement.

- Depending upon its configuration, the instrument will try up to 10 times or more. Information is accumulated until it gets a good measurement or generates an error code.
- Consequently, it is very important that the aiming point on the target remain constant for the entire measurement time. If you move the instrument off the aiming point, it will generate an error code instead of capturing a speed reading.

After you release the **TRIGGER** the instrument will display the most recent speed reading and the distance at which it was captured or an error code. When the most recent speed reading is displayed, the display screen will look similar to Figure 19.

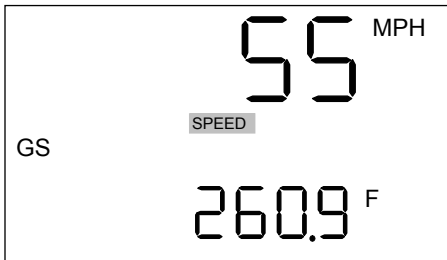

Figure 19. Sample Speed Measurement - Weather Filter ON



When the Weather Filter is activated, the word "**FiLTeR**" appears at the bottom of the display screen. Once a successful speed measurement is completed, the distance measurement overwrites this part of the display. The "**GS**" display feature appears on the screen until the Weather Filter is no longer active.

Section #3 – Survey Measurements



Your UltraLyte LR B may not include the Survey Mode. It is a factory-defined option that is set when the instrument is shipped.

In any survey, there are four measurements to be taken: slope distance, inclination, horizontal distance, and vertical distance.

Figure 20 defines the four measurements and shows the relationships among them.

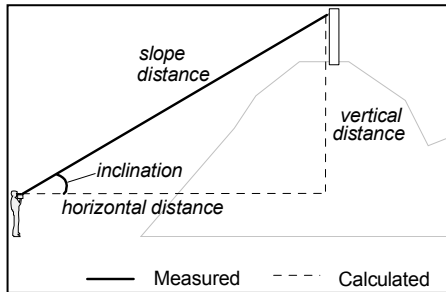

Figure 20. Survey Measurements



The UltraLyte LR B takes only slope distance measurements, and has no way to measure angles.

When the Survey Mode is *active*:

- The triangle icon in the lower, left corner of the display screen indicates that the instrument will take a slope distance measurement.
- The "SURVEY" indicator appears near the center of the display screen. This means that the instrument is in Survey Mode and is prepared to take a slope distance measurement.
- Unlike the Speed Mode, if the in-scope red aiming dot is no longer active, you will need to press the **TRIGGER** twice. The 1st button press turns ON the aiming dot. The 2nd button press fires the laser.
- Dashes indicate where the range measurement will appear.
- "F" means the distance will be measured in feet. ("M" indicates meters.)

Refer to the instructions below to activate the Survey Mode and take a range measurement.

1. Ensure that the UltraLyte LR B is powered ON.
2. Press the **SURVEY MODE button** to activate the Survey Mode. The LCD screen on the rear panel should look similar to Figure 21.

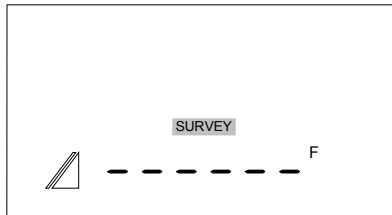

Figure 21 Initial Survey Measurement Screen



If your UltraLyte LR B does not include the Survey Mode, pressing the **SURVEY MODE button** serves no purpose.

3. Aim the instrument at the target and press the **TRIGGER**. A low-pitched growl begins, indicating the instrument is trying to acquire a lock on the target.
4. Continue to press the **TRIGGER** and keep the instrument sighted on the target until you hear a beep.
 - *A double, high-pitched beep* means that a distance was measured.
 - *A low-pitched beep* means that a measurement error occurred.

When the instrument succeeds in taking a measurement, you will hear a double, high-pitched beep, The distance measured will be projected on the scope, just below the aiming dot. and the display screen will look similar to Figure 22.



Figure 22. Sample Survey Measurement Display

Section #4 – Instrument Tests

There are five tests that allow you to verify the UltraLyte LR B's mechanics. These tests include:

- Display Integrity Test
- Scope Alignment Test
- Reference Frequency Test
- Fixed Distance Test
- Delta Distance Test



Your UltraLyte LR B may not include the Reference Frequency Test or the Delta Distance Test. These two tests are factory-defined options that are set when the instrument is shipped.

Display Integrity Test

The Display Integrity Test allows you to verify that all display segments are operating. LTI suggests that you do this test periodically. Refer to the instructions and Figure 23 below to test the display integrity.

1. Ensure that the UltraLyte LR B is powered ON.
2. Press the **TEST OPTIONS** button. The display should look like Figure 23.

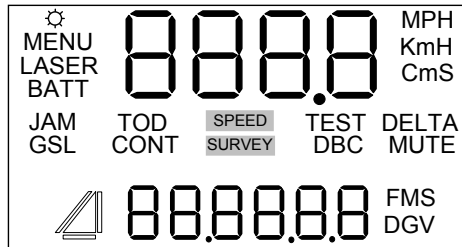

Figure 23. Display Integrity Test

3. Compare the instrument's display to the figure above. If any segment fails to display, contact Laser Technology, Inc. to arrange for repair. See the inside front cover for LTI contact information.



You may also test the display integrity at power ON, by holding the **TRIGGER** (see page 14).

Scope Alignment

The scope alignment is set at the factory when the instrument is shipped. A heavy blow is the only reason that the scope might ever go out of alignment. This sections includes the Scope Alignment Test and the Scope Alignment Procedure. LTI suggests that you do this test periodically. The Scope Alignment Procedure will only be necessary if the Scope Alignment Test shows that the scope is out of alignment.

Scope Alignment Test

This test uses sound to indicate when the scope is on-target. Refer to the instructions below to do the Scope Alignment Test.

1. Select a target. Choose a prominent target with well-defined horizontal and vertical edges. The target's reflective qualities and distance should be such that you can clearly hear a change in pitch of the test tone as you pan the instrument over the edges of the target. A telephone pole is an excellent choice. Make sure there is nothing behind the target that the instrument might detect, so you know without a doubt that any change in pitch is due strictly to the target.
2. Ensure that the UltraLyte LR B is powered ON.
3. Press the **TEST OPTIONS** button two times to activate the Test Tone display screen. It should look like Figure 24.

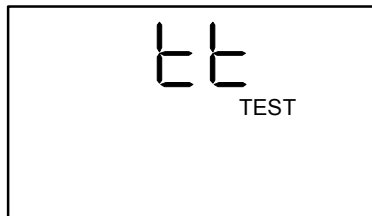

Figure 24. Test Tone Display Screen

4. Scan the target. Press and hold the TRIGGER while panning the instrument across the target. The tone changes pitch when the instrument acquires the target. The highest pitch - the on-target tone - should occur when the scope's red aiming dot is centered on the target. Scan the target both horizontally and vertically.
 - If the frequency drops off at equal distances from the center of the aiming dot, *the instrument needs no adjustment.*
 - Otherwise, *continue with the Alignment Procedure.*



- When checking vertical alignment to a close target, be aware of the offset between the center of the scope and the center of the transmit lens, which is 2 inches.
- If you need assistance, contact Laser Technology, Inc. See the inside front cover for LTI contact information.

Scope Alignment Procedure

The point of this procedure is to align the laser's point of impact with the in-scope red aiming dot, using sound to indicate when the scope is on-target. To align the scope properly, you will need:

- Two metric Allen wrenches to expose and turn the scope adjustment screws. One 2.5 mm and one 1.5 mm.
- A target at which to aim the instrument.
- A highly stable base for the instrument. A tripod is recommended.

Selecting a Target

The target that you choose is critical to the success of the alignment procedure. The target should be reflective; and large enough that you can see it from a distance, but small enough to be an accurate indicator of where the laser beam is hitting.



- A bicycle reflector at least three inches in diameter is recommended.
- The target should be at least 700 feet (200 meters) from the instrument. It should be silhouetted against the sky, with no other targets in the area. That's so you can be certain of the general area that the laser is hitting.

Refer to the instructions below to do the Scope Alignment Procedure.

1. Steady the instrument on a steady base.
2. Expose the adjustment screws. Using a 2.5 mm Allen wrench, remove the cover screws as shown in Figure 25.

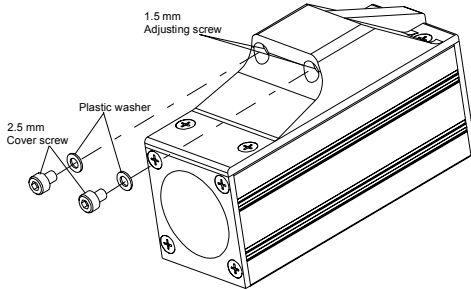

Figure 25. Scope Adjustment Screws



Each cover screw assembly includes a small plastic washer. It is imperative that you not lose the washers. Failing to replace them renders the scope at risk to water damage.

3. Ensure that the UltraLyte LR B is powered ON.
4. Press the **TEST OPTIONS** button two times to activate the Test Tone display screen. It should look like Figure 24 on [page 34](#).
5. Select a target ([see page 35](#)).
6. Scan the target. Press and hold the **TRIGGER** while panning the instrument across the target. When the tone achieves its highest pitch, the laser light beam is hitting the target.
7. Adjust the scope use a 1.5 mm Allen wrench to turn the adjustment screws. Adjust the position of the scope aiming dot, as shown in Figure 26.

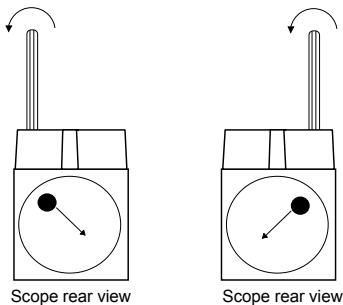

Figure 26. Adjusting the Scope

8. Check the alignment one last time. If the instrument does not pass, repeat the Alignment Procedure ([steps 1-7 on page 36](#)).
9. Replace the plastic washers and cover screws when the instrument passes the alignment test.



If you need assistance, contact Laser Technology, Inc. See the inside front cover for LTI contact information.

Reference Frequency Test



Your UltraLyte LR B may not include the Reference Frequency Test. It is a factory-defined option that is set when the instrument is shipped.

The Reference Frequency Test allows you to check the accuracy of the UltraLyte LR B's internal timing circuitry. During the test, a frequency counter is attached to the UltraLyte LR B's serial port, and the Tx line of the instrument's serial port is toggled ON and OFF. The frequency counter checks the accuracy of that interval.



The Reference Frequency Test should be done by a qualified technician. Specific details about the test are located in the UltraLyte Periodic Certification Manual. If you need assistance, contact Laser Technology, Inc. See the inside front cover for LTI contact information.

Instrument Confidence Checks

There are several ways to verify the measurement accuracy of a Lidar instrument. You can verify it directly by measuring the speed of an object traveling at a known speed, but this is seldom practical. The nature of Lidar is such that it cannot be tricked by a vibrating object, such as a tuning fork, into displaying a velocity. For these reasons, LTI has designed the Fixed Distance Test and the Delta Distance Test. LTI suggests that you do one of these tests each time the instrument is taken on duty.



Your UltraLyte LR B may not include the Delta Distance Test. It is a factory-defined option that is set when the instrument is shipped.

These tests verify the accuracy of the two key elements of Lidar speed measurement:

- Precise time measurements
- Ability to make mathematical calculations

When setting up an area for these tests, LTI recommends:

- Permanently installing the test area in a convenient location. The test area must establish a permanent, known distance between a shooting mark and a target (Fixed Distance Test) or between a shooting mark and two targets (Delta Distance Test).
- Using a metal tape to measure the distance; this will ensure that the measurement is accurate.

Other considerations:

- The shooting mark is where the operator stands to do the test, and can be an "X" painted on the pavement.
- A target can be any flat, permanent structure—a sign or wall, for example—painted with a bull's eye or other aiming point.
- The shooting mark and the target(s) must form a straight line.
- The distance specified is horizontal distance. Horizontal distance is measured along a straight, level path from the shooting mark to the center of the aiming point.
- The manner in which you stand and hold the instrument both affect the test measurements. For exact readings, carefully hold the instrument so it is directly over the middle of the X.

Fixed Distance Test

The Fixed Distance Test requires one target.

If your UltraLyte LR B measures Miles per Hour and Feet,
LTI recommends that the target should be 175 feet from the shooting mark. [See Figure 27\(A\) on page 39.](#) If there is not enough space available, that specific distance is not crucial. However, the distance between the target and the shooting mark must be a multiple of 1 foot, not a fraction of a foot.

If your UltraLyte measures Kilometers per Hour and meters,
LTI recommends that the target should be 60 meters from the shooting mark. [See Figure 27\(B\) on page 39.](#) If there is not enough space available, that specific distance is not crucial. However, the distance between the target and the shooting mark must be a multiple of 1 meter; not a fraction of a meter.

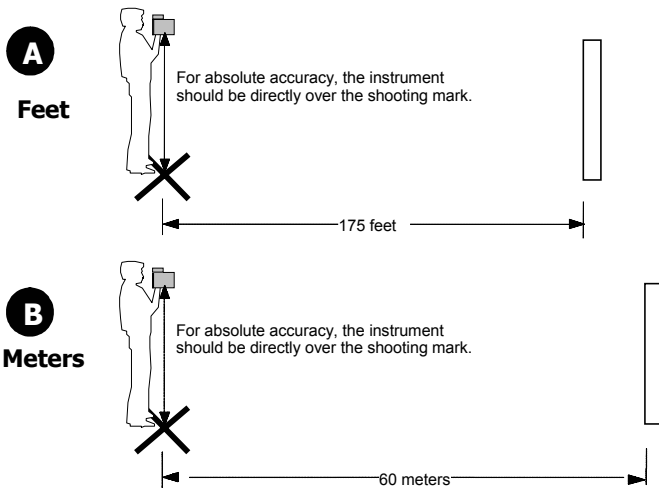

Figure 27. Fixed Distance Test

Refer to the instructions below and Figure 30 above to do the Fixed Distance Test.

1. Stand on the shooting mark.
2. Ensure the UltraLyte LR B is powered ON and that the Speed Mode is active.
3. Aim at the target.
4. Press the **TRIGGER**.
5. Check the display. The speed reading should be zero. A reading of zero verifies the timing accuracy of the instrument and is identical in nature to an accurate velocity reading of a vehicle moving at any speed.
 - *MPH results:* The displayed distance should read from 174.5 to 175.5 feet if your *fixed distance* was 175 feet.
 - *KmH results:* The displayed distance should read from 59.8 to 60.2 meters if your *fixed distance* was 60 meters.



If you need assistance, contact Laser Technology, Inc. See the inside front cover for LTI contact information.

Delta Distance Test



Your UltraLyte LR B may not include the Delta Distance Test. It is a factory-defined option that is set when the instrument is shipped.

The Delta Distance Test requires two targets.

If your UltraLyte LR B measures Miles per Hour and Feet, LTI recommends that the first target should be 150 feet from the shooting mark, and the second should be 175 feet from the mark. See Figure 28(A). If there is not enough space available, that specific distance is not crucial. However, the distance between the target and the shooting mark must be a multiple of 1 foot, not a fraction of a foot.

If your UltraLyte measures Kilometers per Hour and meters, LTI recommends that the first target should be 45 meters from the shooting mark, and the second should be 55 meters from the mark. See Figure 28 (B). If there is not enough space available, that specific distance is not crucial. However, the distance between the target and the shooting mark must be a multiple of 1 meter; not a fraction of a meter

Refer to the instructions below and Figure 28 as a guide for positioning the targets and the shooting mark.

1. Install the farther target.
2. Measure 175 feet (or 55 meters) to the shooting mark and mark the shooting spot.
3. Measure from the shooting mark 150 feet (or 45 meters) to the second target.
4. Mark that spot and install that target.

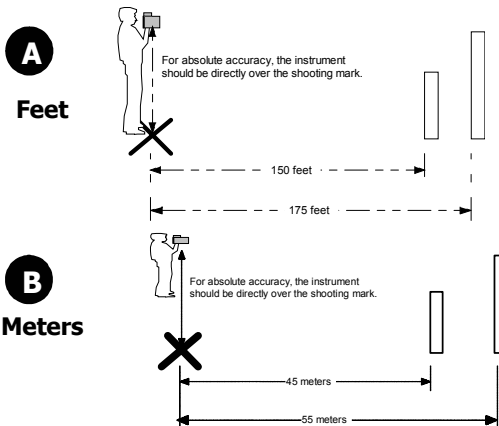

Figure 28. Delta Distance Test

Refer to Table 8 (below) and Figure 28 (see page 40) to do the Delta Distance Test. Note that, for display purposes, each measurement is rounded to whole feet or tenths of meters.

Table 8. Delta Distance Test

Action	MPH Results	KmH Results
1. Stand on the shooting mark. 2. Ensure that the UltraLyte LR B is powered ON and that the Speed Mode is active.		
3. Press the TEST OPTIONS button repeatedly until the screen displays "d1" and the DELTA indicator starts to blink.		
4. Aim to the far target and press the TRIGGER . 5. Check the display.	<p>The screen displays the distance to the target ± 1 ft. The display should read 174, 175, or 176 ft.</p>	<p>The screen displays the distance to the target ± 15 cm. The display should read from 54.8 to 55.2 m.</p>
6. Press the TEST OPTIONS button. The screen displays "d2."		
7. Aim to the near target and press the TRIGGER .	<p>The screen displays the distance to the target ± 1 foot. The display should read from 149, 150, or 151 ft.</p>	<p>The screen displays the distance to the target ± 15 cm. The display should read from 44.8 to 45.2 m.</p>
8. Press the TEST OPTIONS button.	<p>The screen displays the simulated speed ± 1 mph and the difference between the two distances ± 6 inches.</p>	<p>The screen displays the difference between the two distances ± 30 cm.</p>

If the targets are shot in reverse order, the display is the same, but appears as a negative number

Delta Distance Test Results

- *MPH results:* If the difference is 25 feet, the displayed simulated speed should be 49, 50, or 51 mph, and the distance should be 24.5, 25.0, or 25.5 feet.
- *KmH results:* If the difference is 10 meters, the distance should be from 9.70 to 10.30 meters.



If you need assistance, contact Laser Technology, Inc.
See the inside front cover for LTI contact information.

Section #5 – Maintenance

Operating Temperature

The instrument is rated for a temperature range of -22° F to +140° F (-30° C to +60° C). Do not expose the instrument to temperatures outside that range.

Moisture and Dust Protection

The instrument is sealed to provide protection from normally encountered field conditions. It is protected from dust and rain. The instrument features temporary submersion resistance.

Shock Protection

The UltraLyte LR B is a precision instrument and should be handled with care. It will withstand a reasonable drop shock. If you drop the instrument, however, check the scope alignment before using the instrument for measurement (see page 34).

Cleaning and Storage

Clean the instrument after each use, before returning it to its case. Check for the following:

- *Excess moisture.* Towel off excess moisture and air dry the instrument at room temperature.
- *Exterior dirt.* Wipe exterior surfaces clean. Use isopropanol to remove dirt and fingerprints from the scope exterior.
- *Dirty lenses.* Use a lens brush to remove surface dust and loose particles from the front panel lenses. To clean a lens, moisten it with lens cleaning solution and wipe it with a clean cloth or lens tissue.
- *Batteries.* If you won't be using the instrument again soon, remove the batteries before storing it.

Caring for the Scope

Do not attempt to lubricate the scope. It is sealed from within using o-rings and special compounds. All seals are permanent and require no maintenance.

Use a lens brush to remove surface dust and loose particles. To clean a lens, moisten it with lens cleaning solution and wipe it with a clean cloth or lens tissue.

The adjustment screws are permanently lubricated; do not attempt to lubricate them. Keep the cover screws and sealing washers in place except when the scope is being aligned.



For information about the Scope Alignment Test and Procedure, [see pages 34-37](#).

Checking the Screen Display

The instrument provides a method of verifying the display integrity. For more information, [see page 14](#) or [page 33](#).

Resetting the Factory Default Settings

To return the Scope Brightness option to its factory default setting, see [page 20](#).

Section #6 – Serial Data Interface

The UltraLyte serial interface uses RS-232 +/-12V signal levels and data format. Figure 29 shows the pin-out assignments for the UltraLyte LR B's serial port.

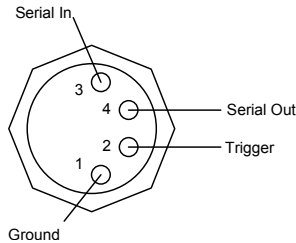

Figure 29. Serial Port Pin Assignments

Data Formats

There are two specific data formats.

- *20-20 format*: Identical to that of the Laser Technology Marksman 20/20 speed detection instrument. The 20-20 format is applied only when the Speed Mode is active.
- *Criterion 400 format*: Identical to that of the horizontal vector message from the Laser Technology Criterion family of survey instruments. The Criterion format is applied only when the Survey Mode is active.



Your UltraLyte LR B may not include the Survey Mode. It is a factory-defined option that is set when the instrument is shipped.

Format Parameters

Table 9 lists the format parameters.

Table 9. Serial Data Format Parameters

Parameter	Value
BPS	9600 (20-20 format)
	4800 (Criterion format)
Start bit	1
Data bits	8
Stop bit	1
Parity	no

Regardless of the format, all data values are automatically available at the serial port after each measurement. The version ID requests is the only query the UltraLyte LR B accepts.

20-20 Download Format

Version ID Requests

When the Speed Mode is active, the instrument accepts 20-20 format requests for the firmware version ID.

The format is as follows:

ID<CR>[<LF>]

ID	The request identifier.
<CR>	A carriage return.
<LF>	An optional line feed character.

The instrument's response is as follows:

ulmodel -versionid, date, csum<CR><LF>

ulmodel	The UltraLyte model (UL100).
-versionid	The version ID of the internal firmware (preceded by a hyphen).
date	The effective date of the firmware version (MM/DD/YY format).
csum	Hexadecimal checksum consisting of the lower two bytes of the firmware checksum.
<CR><LF>	Carriage return/line feed.

Example Version ID Messages

Request: ID

Response: UL100-3.01,03/14/02,2DC6

Speed/Range Data Message Format

Speed and range data downloaded in 20-20 Mode has the following general format:

speed, range <CR><LF>

Speed The speed measurement. Legal values are 000 to 199 MPH (000 to 320 KmH). If the target was departing when the measurement was taken, the number will be preceded by a minus sign.

Range The range measurement. Legal values are 0000.0 to 9999.9 (unsigned).

<CR><LF> A carriage return/line feed.



- There are no units indicators. The values are in the instrument's default units.
- If a measurement error occurs, the speed and range values are replaced by an error code in the form Exx, where xx is the error code. For more information about Error Codes, see page 22.

Example Speed/Range Messages

English units: 50,700.0

Metric units: 80,213.4

Criterion 400 Download Format

Version ID Requests

When the Survey Mode is active, the instrument accepts Criterion 400 format requests for the firmware version ID.

The format is as follows:

\$PLTIT,RQ,ID<CR>[<LF>]

\$PLTIT	The Criterion message identifier.
RQ	Indicates a request message.
ID	Indicates the request type.
<CR>[<LF>]	A carriage return and optional linefeed.

The instrument's response is as follows:

\$PLTIT,ID, model, versionid *csum<CR><LF>

\$PLTIT,ID	Identifies the message.
model	Indicates the UltraLyte model (UL100).
versioned	The version ID of the internal firmware.
*csum	An asterisk followed by a hexadecimal checksum. The checksum is calculated by XORing all the characters between the dollar sign and the asterisk.
<CR><LF>	A carriage return/line feed combination, which terminates each Criterion-format message.

Example Version ID Messages

Request: \$PLTIT,RQ,ID

Response: \$PLTIT,ID,UL100,3.01*40

Survey Data Message Format

Range data downloaded in Criterion 400 Mode has the following general format:

\$PLTIT,HV,hd,hu, , , inc,iu,sd,su*cs<CR><LF>

\$PLTIT	The Criterion message identifier.
HV	The Criterion Horizontal Vector message type.
Hd	The horizontal distance. In an UltraLyte LR B this field contains the slope distance.
Hu	The units in which hd is expressed. Legal values are F (feet) or M (meters). Followed by three commas, indicating two null fields for Criterion values not measured by the UltraLyte LR B.
Inc	Inclination measurement. In an UltraLyte LR B this field always contains 0.00.
Iu	Inclination units. Legal values are D (degrees) or G (gradients). In an UltraLyte LR B this field contains the factory default angle units even though the inc value is always zero.
Sd	Slope distance.
Su	Slope distance units. Legal values are F (feet) or M (meters).
*cs	An asterisk followed by a hexadecimal checksum. The checksum is calculated by XORing all the characters between the dollar sign and the asterisk.
<CR><LF>	A carriage return/line feed combination, which terminates each Criterion-format message.

If a measurement error occurs, the message downloads null values for the measurements that failed.

Example Survey Messages

The section uses Slope Distance = 27.5 feet (8.38 meters).

English units: \$PLTIT,HV,27.5,F, , ,0.00,D,27.5,F*3D

Metric units: \$PLTIT,HV,8.38,M, , ,0.00,G,8.38,M*3E

Section #7 – Specifications

Weight:	2.95 lb.	(1.34 kg)
Size:	8.25 2.75 x 11 in.	21 x 7 x 28 cm
Acquisition Time:		
• Speed Mode:	0.3 sec	
• Survey Mode:	0.3 sec	
Speed Accuracy:	±1 mph	±2 kmh
Minimum Range:		
• Speed Mode:	50 ft	(15 m)
• w/ Weather Filter Active:	250 ft	(76 m)
• Survey Mode:	0 ft	(0 m)
Maximum Range:	3280 ft	(1000 m)
Speed Range:	±200 mph	±320 kmh
Range Accuracy:		
• Speed Mode:	±6 in	(±15 cm)
• Survey Mode:	±2 in	(±5 cm)
• To a White target at 150 feet (45 meters):	1 σ	
Range Resolution (Survey Mode):	0.1 ft	(0.01 m)
Beam Divergence:	3 milliradians nominal	
Laser Wavelength:	904 nanometers nominal	
Temperature Range:	-22° F to +140° F	(-30° C to +60° C)
Power:	Two alkaline or NiCad rechargeable C batteries providing up to 25 hours of cordless operation.	
Eye Safety:	FDA Class 1 (CFR 21)	
Environment:	Waterproof to IP 67 and NEMA 6	
Construction:	All aluminum, extruded housing	

Section #8 – Troubleshooting Tips

What You Will See	Required Action
Unit powers OFF by itself. <i>-or-</i> No power at all.	<ul style="list-style-type: none"> • Verify that the batteries are installed correctly. • Replace the batteries. • Keep in mind that the instrument automatically powers OFF if there is no instrument activity for a period of 15 minutes.
The in-scope red aiming dot is not visible.	<ul style="list-style-type: none"> • Press the TRIGGER to activate the red dot. • Press the BRIGHTNESS CONTROL button to increase the intensity of the red dot. • Adjust the polarizing filter.
E01 error code. No range or speed readings.	<ul style="list-style-type: none"> • Can you measure to a wall that is about 50 feet (or 20 meters) away? • Check the scope alignment. • Restore the factory defaults. • When measuring a short range to a small target, aim slightly above the target.
Erroneous readings/not repeatable.	<ul style="list-style-type: none"> • Do you have a clear line of sight? • Check the scope alignment. • Is it raining or foggy. If yes, is the weather filter active? If not, turn it ON. Keep in mind that the minimum range will be 250 feet (76 meters). • When measuring a short range to a small target, aim slightly above the target
No serial communication.	<ul style="list-style-type: none"> • Verify the cable connection.

What You Will See	Required Action
Limited Range.	<ul style="list-style-type: none">• Do you have a clear line of sight?• Rain or fog will reduce the unit's maximum range.• Is the Weather Filter active? If not, turn it ON. Keep in mind that the minimum range will be 250 feet (76 meters).• Keep in mind that acquiring a target through glass will reduce the unit's maximum range.• Make sure the lens is clean.• Check the lens for scratches.
Difficult to acquire target while aiming through windshield.	<ul style="list-style-type: none">• Is the Weather Filter active? If not, turn it ON. Keep in mind that the minimum range will be 250 feet (76 meters).• If the windshield is bubble- shaped, shoot through the center of the windshield.
Difficult to acquire target while aiming through rain or snow.	<ul style="list-style-type: none">• Is the Weather Filter active? If not, turn it ON. If not, turn it ON. Keep in mind that the minimum range will be 250 feet (76 meters).

Index

2

- 20-20
 - download format, 46

A

- about
 - this manual, 5
- accessories, 6
 - UltraLyte Yoke, 12
- acquiring targets
 - difficulties, 54
 - Speed Mode, 27
 - Survey Mode, 29
- adjusting
 - aiming dot, 18
 - scope, 36
 - shoulder stock, 11
- aiming dot
 - appearance, 8
 - intensity, 8, 18
 - not visible, 53
 - resetting default intensity, 20
 - Speed Mode, 23
 - Survey Mode, 31
- angle
 - of shoulder stock, 11
- attaching
 - mounting bracket, 12
 - yoke, 12
 - yoke adapter, 12

B

- BACKLIGHT button, 9, 20
- BATT indicator, 13, 15
- batteries
 - inserting, 13
- battery
 - voltage level, 13
- beeping noise, 21
- br xx, 17, 18
- BRIGHTNESS CONTROL
 - button, 9, 17, 18, 53
- button. *See* specific button
 - names, 9
 - panels, 9

C

- cleaning
 - UltraLyte LR B, 43
- CLEAR, 17, 20, 23
- confidence checks, 37
- cosine effect, 25
 - minimizing, 26
- Criterion 400
 - download format, 48

D

- dEF, [17](#), [20](#)
 - CLEAR, [20](#)
- Delta Distance Test, [40](#)
 - results, [42](#)
- display feature. *See* specific display feature
- display indicators, [15](#)
- Display Integrity Test, [33](#)
- display screen. *See* LCD Screen
- display segment test, [14](#)
 - extending, [14](#)
- display segments
 - LCD screen, [33](#)
 - LCD Screen, [14](#)
- displaying
 - firmware revision number, [19](#)
- doF, [22](#)
- download format
 - 20-20, [46](#)
 - Criterion 400, [48](#)
- dust protection, [43](#)

E

- erroneous readings, [53](#)
- error
 - codes, [22](#)
 - conditions, [21](#)
 - jam detect, [28](#)
- Exx, [17](#), [21](#)
- eye safety, [3](#), [51](#)

F

- F Out, [17](#)
- factory defaults
 - restoring, [20](#), [44](#)
- features
 - of the UltraLyte LR B, [5](#)
- FiLteR, [17](#), [29](#), [30](#)
- filter adjustment ring, [8](#)
- firmware
 - revision number, [19](#)
- Fixed Distance Test, [38](#)
 - results, [39](#)
- flashing
 - BATT indicator, [13](#)
- front view, [6](#)

G

- gating option. *See* Weather Filter
- growling noise, [21](#)
- GS indicator, [15](#), [29](#), [30](#)

I

- in-scope
 - display, [8](#)
- in-scope aiming dot. *See* aiming dot
- installing
 - batteries, [13](#)
- instrument software. *See* firmware
- instrument tests. *See* specific test

J

- JAM indicator, [15](#), [28](#)
- jam tone, [21](#)
- jamming device, [28](#)

L

- LASER indicator, [15](#)
- laser jamming device, [28](#)
- LCD Screen, [7](#)
 - at power ON, [14](#)
 - display segments, [14](#)
- left
 - button panel, [9](#)
- length
 - of shoulder stock, [11](#)
- light filter
 - polarizing, [8](#)
- limited range, [54](#)
- line of sight, [24](#)

M

measured speed
 true speed, 25
measurement errors, 22
minimizing
 cosine effect, 26
minimum
 range, 51
minimum range
 Weather Filter, 29
Mode
 Speed, 23
Mode,
 Survey, 31
moisture protection, 43
mounting bracket, 12

N

names
 of buttons, 9
negative value
 speed display, 28
no measurements or readings,
 53
no power, 53
noise. *See* sounds

O

operating temperature, 43

P

polarizing
 light filter, 8
positive value
 speed display, 28
power
 OFF, 14
 ON, 14
POWER OFF button, 9, 14
precautions, 3
problem
 acquiring target, 53
 acquiring targets, 54
 not power ON, 53
 serial communication, 53

R

radio frequency interference.
 See RFI
rear view, 6
rEF, 17
Reference Frequency Test, 37
refolding
 shoulder stock, 11
restoring
 factory defaults, 20, 44
 revision number
 firmware, 19
RFI, 22
right
 button panel, 9
ringing noise, 21
roadside
 selecting location, 24

S

safety
precautions, 3

scope
adjusting, 36
caring for, 44

scope alignment, 34
procedure, 35
test, 34

SCOPE BRIGHTNESS button, 18

screen display
checking, 44
selecting
roadside location, 24

sensors, 7

serial communication
problem with, 53

serial data
format parameters, 45
formats, 45
interface, 45

serial port
connector, 7
pin assignment, 45

shock protection, 43

shoulder stock
adjusting, 11
refolding, 11
unfolding, 10

sighting scope, 8

sounds, 21

specifications, 51

speed display
positive/negative value, 28

SPEED indicator, 16, 23, 29

Speed Mode, 23
aiming dot, 23
in-scope display, 8
Weather Filter, 29

SPEED MODE button, 9

storing
UltraLyte LR B, 43

SURVEY indicator, 16

Survey Mode, 31
aiming dot, 31
in-scope display, 8

SURVEY MODE button, 9, 19, 32

T

temperature
range, 3, 43, 51
too cold or too hot, 22

test area
considerations, 38

TEST indicator, 16, 34

TEST OPTIONS button, 9, 33, 34, 36, 41

troubleshooting, 53

true speed
measured speed, 25

tt, 17, 34

U

unit
powers off, 53

using the shoulder stock
left-handed, 10
right-handed, 10

V

V indicator, 16

views
of the scope, 36
of the UltraLyte LRB, 6

voltage level
batteries, 13

W

Weather Filter, 29

WEATHER FILTER button, 9, 29

windshield
aiming through, at targets, 54

Y

yoke
adapter, 12
attaching, 12